

**Features:**

- MEMS Technology
- Direct pin to pin drop-in replacement for industry-standard packages
- Ultra-low phase jitter: 0.5 pSec (12 kHz to 20 MHz)
- LVCMOS/HCMOS Compatible Output
- Industry-standard package 2.0 x 1.6, 2.5 x 2.0, 3.2 x 2.5, and 5.0 x 3.2 mm x mm
- Pb-free, RoHS and REACH compliant
- Fast delivery times

**Typical Applications:**

- Fibre Channel
- Server and Storage
- GPON, EPON
- 100M / 1G / 10G Ethernet
- Ruggedized equipment in harsh operating environment

**Electronic Specifications:**

<b>Frequency Range</b>	1.000 MHz to 110.000MHz	
<b>Frequency Stability</b>	See Part Number Guide	Inclusive of initial tolerance at +25°C, 1 <sup>st</sup> year aging at +25°C, and variations over operating temperature, rated power supply, voltage and load (15 pF±10%)
<b>Operating Temperature</b>	-55°C of +125°C	
<b>Supply Voltage (Vdd) ±10%</b>	See Part Number Guide	
<b>Current Consumption</b>	3.8 mA typ./ 4.7 mA max 3.6 mA typ./ 4.5 mA max 3.5 mA typ./ 4.5 mA max	No load condition, f = 20 MHz, Vdd = +2.8 V, +3.0 V or +3.3 V No load condition, f = 20 MHz, Vdd = +2.5 V No load condition, f = 20 MHz, Vdd = +1.8 V
<b>OE Disable Current</b>	4.5 mA max 4.3 mA max	Vdd = +2.5 V, or +3.3 V, OE = Low, output is high Z state Vdd = +1.8 V, OE = Low, output is high Z state
<b>Standby Current</b>	2.6 µA typ./ 8.5 µA max, 1.4 µA typ./ 5.5 µA max 0.6 µA typ./ 4.0 µA max	Vdd = +2.8 V to 3.3 V, $\overline{ST}$ = low Vdd = +2.5 V, $\overline{ST}$ = Low Vdd = +1.8 V, $\overline{ST}$ = Low
<b>Waveform Output</b>	LVCMOS/HCMOS	
<b>Symmetry</b>	45%/55%	50% of waveform
<b>Rise / Fall Time</b>	1.0 nSec typ./ 2.0 nSec max 1.3 nSec typ./ 2.5 nSec max	Vdd = +2.5 V, +2.8 V, 3.0 V or 3.3 V from 20% to 80% of waveform Vdd = +1.8 V, from 20% to 80% of waveform
<b>Logic "1"</b>	90% of Vdd min	
<b>Logic "0"</b>	10% of Vdd max	
<b>Input Voltage High</b>	70% of Vdd min	Pin 1, OE or $\overline{ST}$
<b>Input Voltage Low</b>	30% of Vdd max	Pin 1, OE or $\overline{ST}$
<b>Input Pull-up Impedance</b>	50 Ω min / 87 kΩ typ./ 150 kΩ max 2.0 MΩ min	Pin 1, OE logic high or logic low, or $\overline{ST}$ logic high Pin 1, $\overline{ST}$ logic low
<b>Startup Time</b>	5 mSec max	Measured from the time Vdd reaches its rated minimum values
<b>Enable/Disable Time</b>	130 nSec max	F = 110 MHz, For other frequencies, T <sub>oe</sub> = 100 nSec + 3 * clock periods
<b>Resume Time</b>	5 mSec max	Measured from the time $\overline{ST}$ pin crosses 50% threshold.
<b>RMS Period Time</b>	1.6 pSec typ./ 2.5 pSec max 1.9 pSec typ./ 3.0 pSec max	F = 75 MHz, Vdd = +2.5 V, +2.8 V, +3.0 V or +3.3 V F = 75 MHz, Vdd = +1.8 V
<b>Peak-to-Peak Period Jitter</b>	12 pSec typ./ 20 pSec max 14 pSec typ./ 25 pSec max	F = 75 MHz, Vdd = +2.5 V, +2.8 V, +3.0 V or +3.3 V F = 75 MHz, Vdd = +1.8 V
<b>RMS Period Time (random)</b>	0.5 pSec typ./ 0.8 pSec max 1.3 pSec typ. / 2.0 pSec max	F = 75 MHz, Integration bandwidth = 900 kHz to 7.5 MHz F = 75 MHz, Integration bandwidth = 12.0 kHz to 20.0 MHz

**Notes:**

- All min and max limits are specified over temperature and rated operating voltage with 15pF output unless otherwise stated.
- Typical values are at +25°C and nominal supply voltage.

**Ordering Information:**

Part Number Guide						
Packages	Input Voltage	Operating Temperature	Output Drive Strength	Stability (ppm)	Select Function	Frequency
IM830B – 5.0 x 3.2 IM830C – 3.2 x 2.5 IM830D – 2.5 x 2.0 IM830E – 2.0 x 1.6	1 = +1.8 V 6 = +2.5 V 2 = +2.7 V 7 = +3.0 V 3 = +3.3 V	7 = -55°C to +125°C	- = Default (see tables 2 through 6)	F = ±20 A = ±25 Z = ±30 B = ±50	H = Tri-state S = Standby O = N/C	- Frequency

**Sample Part Number: IM830C-67-FS-10.0000MHz**

This 10.0000 MHz oscillator in a 3.2 x 2.5 package with stability ±20 ppm from -55°C to +125°C using a supply voltage of +2.5 V. The Output Drive Strength (Rise and Fall Time) is 2.01 nSec per Table 3 with 30 pF load. With Pin 1 function as Standby

**Sample Part Number: IM830B-17EAT-66.0000MHz**

This 66.0000 MHz oscillator in a 5.0 x 3.2 package with stability ±25 ppm from -55°C to +125°C using a supply voltage of +1.8 V. The Output Drive Strength (Rise and Fall Time) is 2.94 nSec per Table 1 with 30 pF load. With Pin 1 function as Tri-state

**Notes:**

- Not all options are available at all frequencies and temperatures ranges.
- Please consult with sales department for any other parameters or options.
- Oscillator specification subject to change without notice.

Absolute Maximum Limits	
Storage Temperature	-65°C to +150°C
Supply Voltage (Vdd)	-0.5 VDC to 4.0 VDC
Electrostatic Discharge	2000 V max
Solder Temperature (follow standard Pb free soldering guidelines)	260°C max
Junction Temperature	150°C max

**Test Circuit**

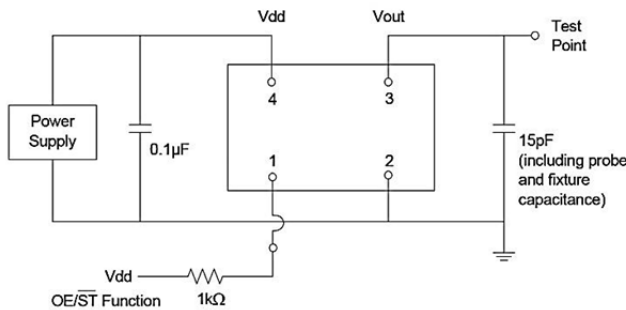

**Waveform**

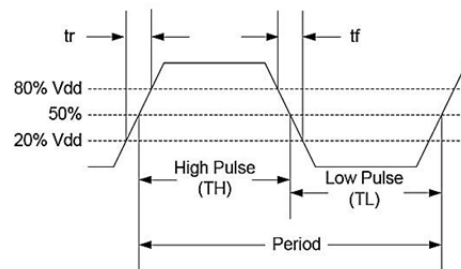

Performance Plots:

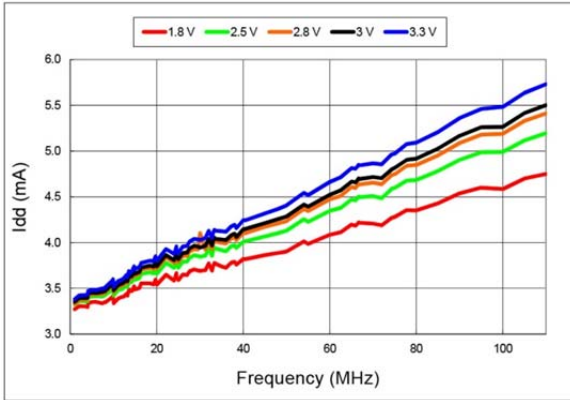

Figure 1: Idd vs Frequency

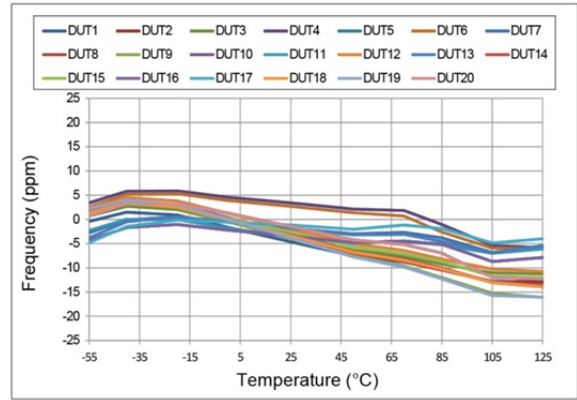

Figure 2: Frequency vs Temperature

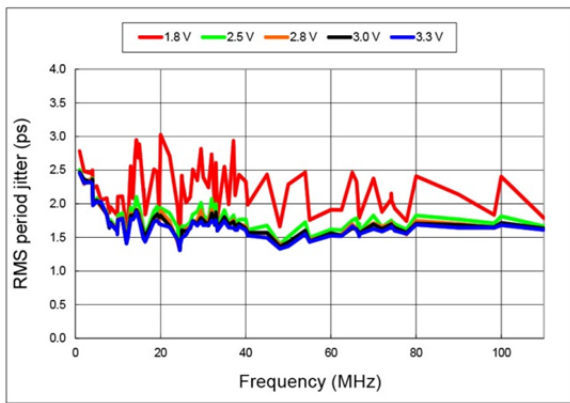

Figure 3; RMS Period Jitter vs Frequency

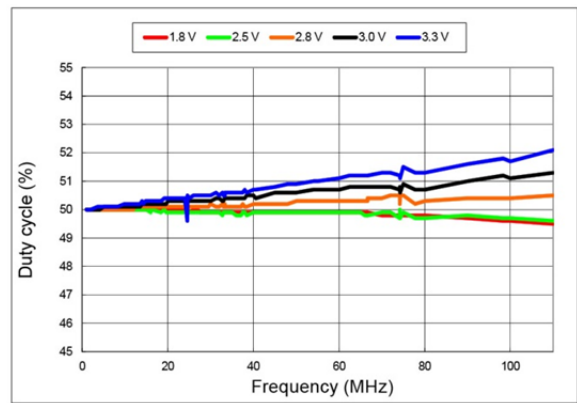

Figure 4: Duty Cycle vs Frequency

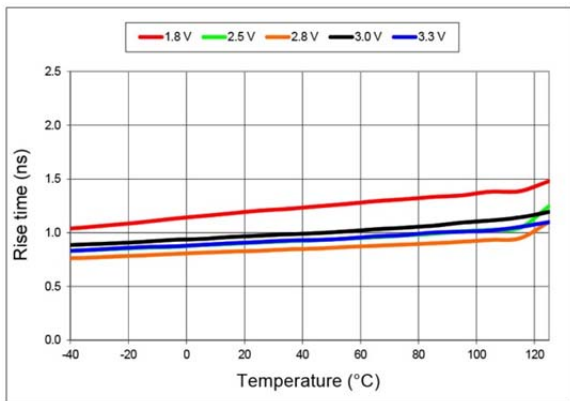

Figure 5: 20% to 80% Rise Time vs Temperature

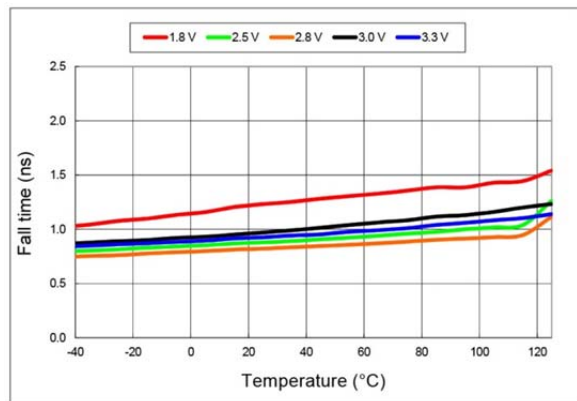

Figure 6: 20% to 80% Fall Time vs Temperature

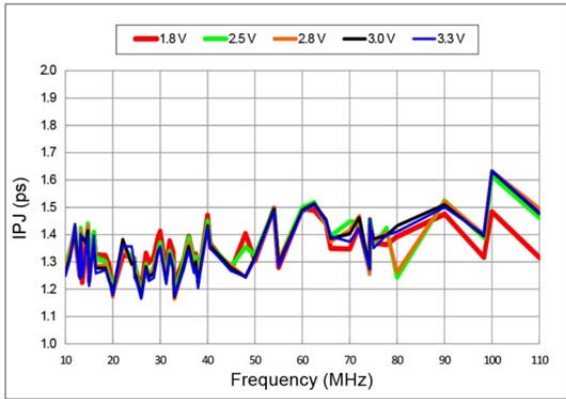

Figure 7: RMS Integrated Phase Jitter Random (12 kHz to 20.0 MHz) vs. Frequency

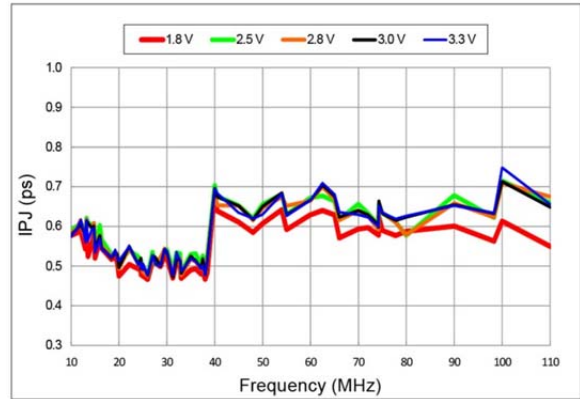
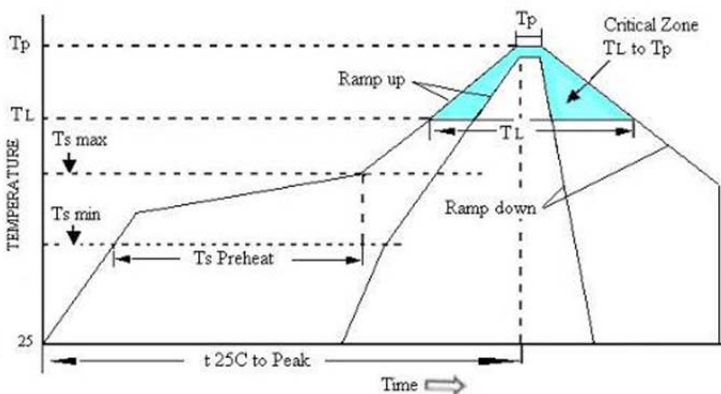

Figure 8: RMS Integrated Phase Jitter Random (900 kHz to 20.0 MHz) vs. Frequency

**Environmental Specifications:**

Environmental Compliance	
Parameter	Condition/Test Method
Mechanical Shock	MIL-STD-883F, Method 2002
Mechanical Vibration	MIL-STD-883F, Method 2007
Temperature Cycle	JESD22, Method A104
Solderability	MIL-STD-883F, Method 2003
Moisture Sensitivity Level	MSL Level 1 at +260°C

**Pb Free Solder Reflow Profile**



Units are backward compatible with +240°C reflow processes

Ts max to TL (Ramp-up Rate)	3°C / second max
Preheat	
Temperature min (Ts min)	150°C
Temperature typ (Ts typ)	175°C
Temperature max (Ts max)	200°C
Time (Ts)	60 to 180 seconds
Ramp-up Rate (TL to Tp)	3°C / second max
Time Maintained Above Temperature (TL)	217°C
Time (TL)	60 to 150 seconds
Peak Temperature (Tp)	260°C max for seconds
Time within 5°C to Peak Temperature (Tp)	20 to 40 seconds
Ramp-down Rate	6°C / second max
Time 25°C to Peak Temperature	8 minute max
Moisture Sensitivity Level (MSL)	Level 1

**Pin Functionally**

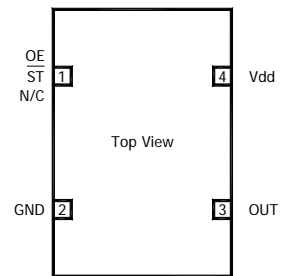
Pin Description				Pin Assignments
Pin	Symbol		Functionality	
1	OE	Tri-state	High or Open = specified frequency output Low = Output is high impedance, only output is disabled.	 <p>Top View</p>
	$\overline{ST}$	Standby	High or Open = specified frequency output. Low = Output is low. Device goes to sleep mode. Supply current reduces to standby current.	
	N/C	No Connect	Any voltage between 0.0 V to Vdd or Open = specified frequency output Pin 1 has no function	
2	GND	Power	Electrical ground	
3	Out	Output	Oscillator output	
4	Vdd	Power	Power supply voltage	
<b>Notes:</b>				
1. In OE or $\overline{ST}$ mode, a pull-up resistor of 10.0 kΩ or less is recommended if Pin 1 is not externally driven. If Pin 1 needs to be left floating, use the NC option.				
2. A capacitor of value 0.1 μF or higher between Pin 4 (Vdd) and Pin 1 (GND) is required.				

**Pin 1 Configuration Options (OE, or  $\overline{ST}$ , or NC)**

Pin 1 of the IM830 can be factory-programmed to support three modes: Output Enable (OE), Standby ( $\overline{ST}$ ) or No Connect (NC).

**Output Enable (OE) Mode**

In the OE mode, applying logic Low to the OE pin only disables the output driver and puts it in Hi-Z mode. The core of the device continues to operate normally. Power consumption is reduced due to the inactivity of the output. When the OE pin is pulled High, the output is typically enabled in <1 μSec.

**Standby  $\overline{ST}$  Mode**

In the  $\overline{ST}$  mode, a device enters into the standby mode when Pin 1 pulled Low. All internal circuits of the device are turned off. The current is reduced to a standby current, typically in the range of a few μA. When  $\overline{ST}$  is pulled High, the device goes through the "resume" process, which can take up to 5 mSec.

**No Connect (NC) Mode**

In the NC mode, the device always operates in its normal mode and outputs the specified frequency regardless of the logic level on Pin 1.

Table 1 below summarizes the key relevant parameters in the operation of the device in OE, ST, or NC mode.

Parameters	OE	ST	NC
Active current 20.0 MHz (max +1.80 VDC)	4.5 mA	4.5 mA	4.5 mA
OE disable current (max +1.80 VDC)	4.3 mA	N/A	N/A
Standby current (typical +1.80 VDC)	N/A	0.6 μA	N/A
OE enable time at 20.0 MHz (max)	130 nSec	N/A	N/A
Resume time from standby (max, all frequency)	N/A	5 mSec	N/A
Output driver in OE disable/standby mode	High Z		N/A

**Table 1 OE vs.  $\overline{ST}$  vs. NC**

Timing Diagrams:

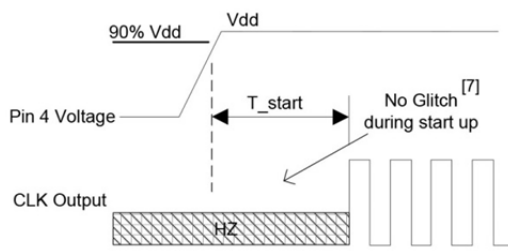

T\_start: Time to start from power-off

Figure 9: Startup Timing (OE/ST Mode)

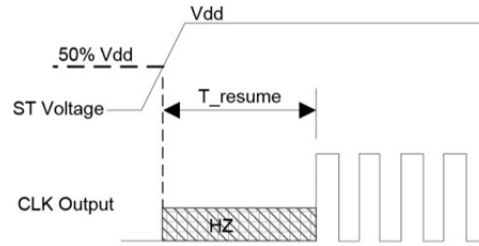

T\_resume: Time to resume from ST

Figure 10: Standby Resume Timing (ST Mode Only)

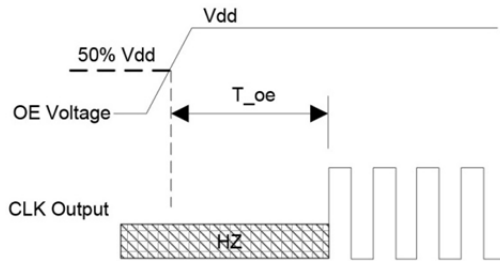

T\_oe: Time to re-enable the clock output

Figure 11: OE Enable Timing (OE Mode Only)

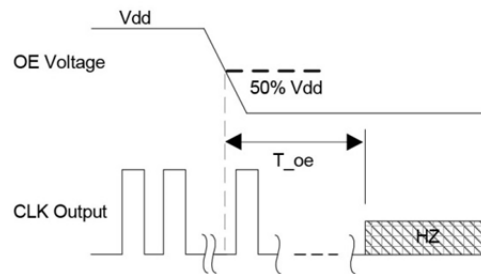

T\_oe: Time to put the output in High Z mode

Figure 12: OE Disable Timing (OE Mode Only)



Selectable Drive Strength Options  
Rise/Fall Time (20% to 80%) vs C<sub>LOAD</sub> Tables

Rise/Fall Time Typ (nS)					
Drive Strength (C <sub>LOAD</sub> )	5 pF	15 pF	30 pF	45 pF	60 pf
L	6.16	11.61	22.00	31.27	39.91
A	3.19	6.35	11.00	16.01	21.52
R	2.11	4.31	7.65	10.77	14.47
B	1.65	3.23	5.79	8.18	11.08
T	0.93	1.91	3.32	4.66	6.48
E	0.78	1.66	2.94	4.09	5.74
U	0.70	1.48	2.64	3.68	5.09
- = Default	0.65	1.30	2.40	3.35	4.56

Table 2: V<sub>dd</sub> = +1.8 V Rise/Fall time for Specific C<sub>LOAD</sub>

Rise/Fall Time Typ (nS)					
Drive Strength (C <sub>LOAD</sub> )	5 pF	15 pF	30 pF	45 pF	60 pf
L	4.13	8.25	12.82	21.45	27.79
A	2.11	4.27	7.64	11.20	14.49
R	1.45	2.81	5.16	7.65	9.88
B	1.09	2.20	3.88	5.86	7.57
T	0.62	1.28	2.27	3.51	4.45
- = Default	0.54	1.00	2.01	3.10	4.01
U	0.43	0.96	1.81	2.79	3.65
F	0.34	0.88	1.64	2.54	3.32

Table 3: V<sub>dd</sub> = +2.5 V Rise/Fall time for Specific C<sub>LOAD</sub>

Rise/Fall Time Typ (nS)					
Drive Strength (C <sub>LOAD</sub> )	5 pF	15 pF	30 pF	45 pF	60 pf
L	3.77	7.54	12.28	19.57	25.27
A	1.94	3.90	7.03	10.24	13.34
R	1.29	2.57	4.72	7.01	9.06
B	0.97	2.00	3.54	5.43	6.93
T	0.55	1.12	2.08	3.22	4.08
- = Default	0.44	1.00	1.83	2.82	3.67
U	0.34	0.88	1.64	2.52	3.30
F	0.29	0.81	1.48	2.29	2.99

Table 4: V<sub>dd</sub> = +2.8 V Rise/Fall time for Specific C<sub>LOAD</sub>

Rise/Fall Time Typ (nS)					
Drive Strength (C <sub>LOAD</sub> )	5 pF	15 pF	30 pF	45 pF	60 pf
L	3.60	7.21	11.97	18.74	24.30
A	1.84	3.71	6.72	9.86	12.68
R	1.22	2.46	4.54	6.76	8.62
B	0.89	1.92	3.39	5.20	6.64
- = Default	0.51	1.00	1.97	3.07	3.90
E	0.38	0.92	1.72	2.71	3.51
U	0.30	0.83	1.55	2.40	3.13
F	0.27	0.76	1.39	2.16	2.85

Table 5: V<sub>dd</sub> = +3.0 V Rise/Fall time for Specific C<sub>LOAD</sub>

Rise/Fall Time Typ (nS)					
Drive Strength (C <sub>LOAD</sub> )	5 pF	15 pF	30 pF	45 pF	60 pf
L	3.39	6.88	11.63	17.56	23.59
A	1.74	3.50	6.38	8.98	12.19
R	1.16	2.33	4.29	6.04	8.34
B	0.81	1.82	3.22	4.52	6.33
- = Default	0.46	1.00	1.86	2.60	3.84
E	0.33	0.87	1.64	2.30	3.35
U	0.28	0.79	1.46	2.05	2.93
F	0.25	0.72	1.31	1.83	2.61

Table 6: V<sub>dd</sub> = +3.3 V Rise/Fall time for Specific C<sub>LOAD</sub>

**Mechanical Details:**

**Package Dimensions and Suggest Land Pattern**

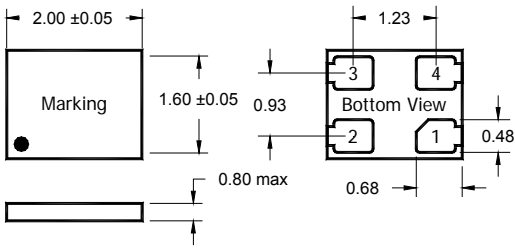
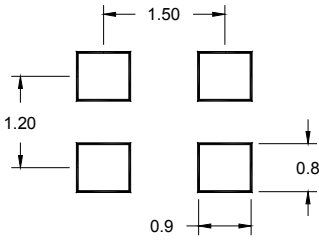
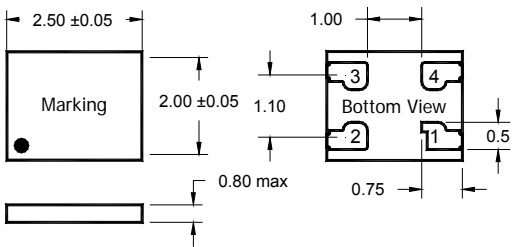
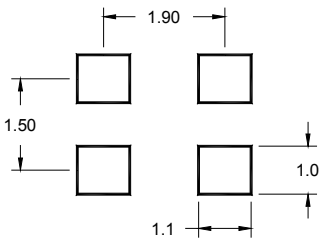
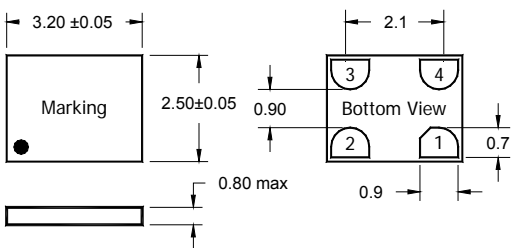
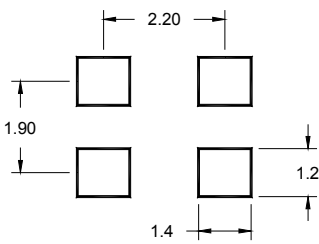
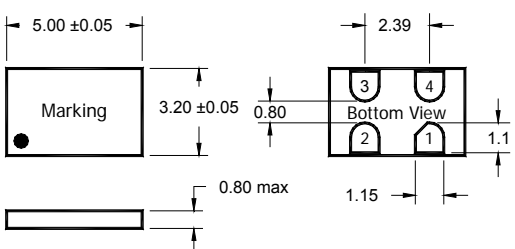
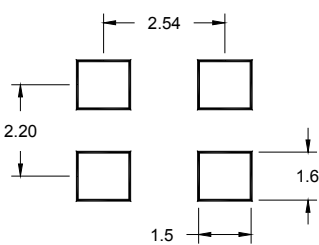
<p>Option E: 2.00 x 1.60 x 0.80 Package</p> 	<p>Suggested Land Pattern</p> 
<p>Option D: 2.50 x 2.00 x 0.80 Package</p> 	<p>Suggested Land Pattern</p> 
<p>Option C: 3.20 x 2.50 x 0.80 Package</p> 	<p>Suggested Land Pattern</p> 
<p>Option B: 5.00 x 3.20 X 0.80 Package</p> 	<p>Suggested Land Pattern</p> 

**Marking**

Line 1 = XXXXX (Lot code)  
Dot to denote Pin 1 location

**Package Information**

Leadframe: C194  
Plating: NiPdAu



**Tape and Reel Dimensions**

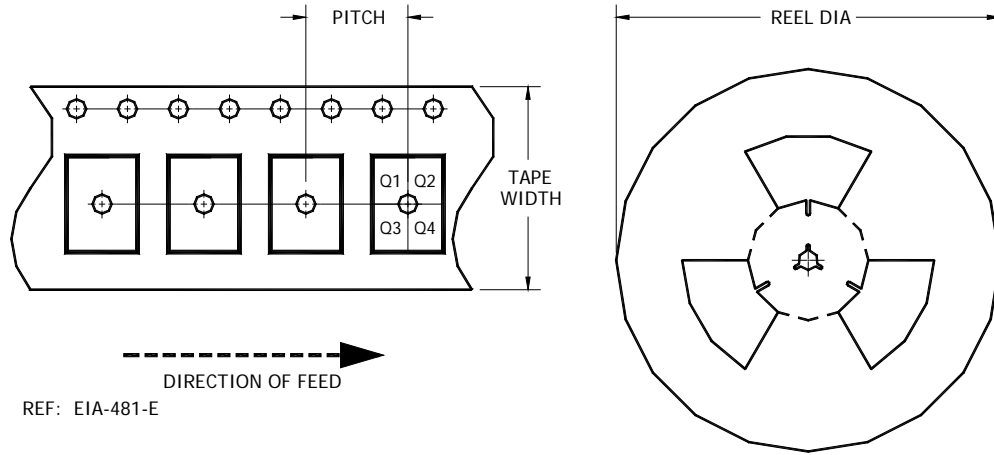

Part Number	Size	Pitch	Tape Width	Pin Orient.	Reel Dia.	Count
IM830B	5.0 x 3.2	8.0 ± 0.1	12.3 max	Q1	180 Dia	1000
					330 Dia	3000
IM830C	3.2 x 2.5	4.0 ± 0.1	8.3 max	Q1	180 Dia	3000
IM830D	2.5 x 2.0	4.0 ± 0.1	8.3 max	Q1	180 Dia	3000
IM830E	2.0 x 1.6	4.0 ± 0.1	8.3 max	Q1	180 Dia	3000

Notes:

- All dimensions are in mm.
- Do not scale drawings.

**PROPRIETARY AND CONFIDENTIAL**

THIS DOCUMENT CONTAINS PROPRIETARY INFORMATION, AND SUCH INFORMATION MAY NOT BE DISCLOSED TO OTHERS FOR ANY PURPOSE NOR USED FOR MANUFACTURING PURPOSES WITHOUT WRITTEN PERMISSION FROM ILSI America.