



DN Series Crystal

- Micro Miniature SM Crystal
- Frequency Range 12.000MHz to 40.000MHz
- RoHS Compliant



ELECTRICAL CHARACTERISTICS	
Parameter	Value
Frequency Range	12.000MHz to 40.000MHz
Frequency Tolerance / Stability	(See Part Number Guide for Option)
Operating Temperature Range	(See Part Number Guide for Option)
Storage Temperature Range	-40°C to +85°C
Aging at +25°C	±3 ppm / year max
Shunt Capacitance	Less than 5pF
Load Capacitance	(See Part Number Guide for Option)
Equivalent Series Resistance (ESR)	(See ESR Chart)
Mode of Operation	(See ESR Chart)
Drive Level	1µW to 100µW

ENVIRONMENTAL & MECHANICAL SPEC

Shock	MIL-STD-883, Method 2002 Cond B
Solderability	MIL-STD-883, Method 2003
Solvent Resistance	MIL-STD-202, Method 215
Vibration	MIL-STD-883, Method 2007, Cond A
Gross Leak Test	MIL-STD-883, Method 1014, Cond C
Fine Leak Test	MIL-STD-883, Method 1014, Cond A2
MSL	Level 1 per IPC/JEDEC J-STD 20
Reflow Conditions	260°C max 10 sec per IPC/JEDEC J-STD 20

EQUIVALENT SERIES RESISTANCE CHART

Frequency Range	ESR	Mode / Cut
12.000MHz to 16.000MHz	60Ω max	Fund / AT
16.000MHz to 30.000MHz	50Ω max	Fund / AT
30.000MHz to 40.000MHz	40Ω max	Fund / AT

PART NUMBER GUIDE

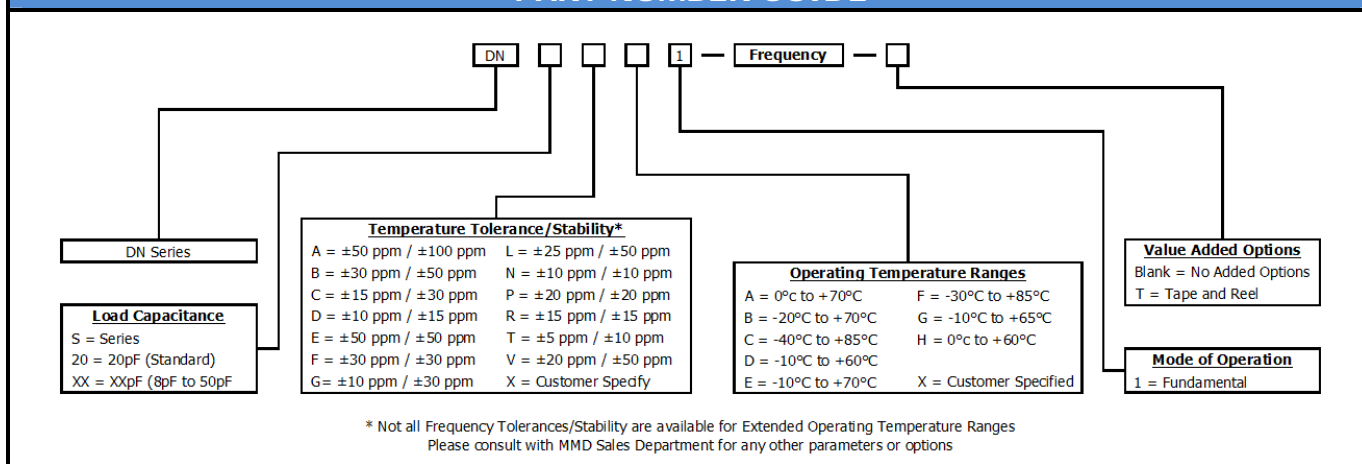

QUALITY MANAGEMENT SYSTEM
 CERTIFIED BY DNV

MMD Components, 30400 Esperanza, Rancho Santa Margarita, CA, 92688
 Phone: (949) 709-5075, Fax: (949) 709-3536, www.mmdcomp.com
 Sales@mmdcomp.com

RoHS
 Free Compliant

DN Series Crystal

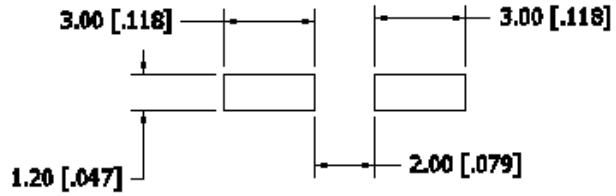
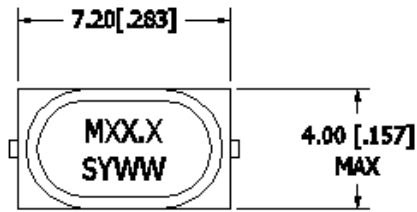

**SUGGESTED
LAND PATTERN**

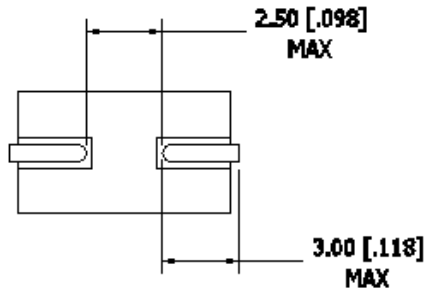
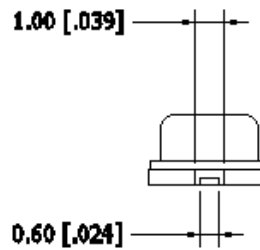
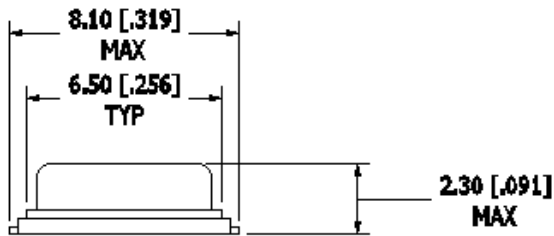

NOTES:

1. BASE OR UNDER CONDUCTOR - NICKEL THICKNESS 1.3 TO 1.8 MICRONS
2. FINAL PLATING: GOLD (99.97%) 0.8 TO 1.2 MICRONS

1. APPLICABLE STANDARDS / SPECIFICATIONS: ANSI Y14.5M, DIMENSIONS AND TOLERANCES.
2. DIMENSIONS ARE MILLIMETERS [INCHES]. MILLIMETERS ARE THE CONTROLLING DIMENSIONS, INCHES ARE FOR REFERENCE ONLY.
3. THE PIN NUMBERS ARE FOR REFERENCE ONLY AND ARE NOT TO BE MARKED ON THE UNIT.
4. AN EXTERNAL BYPASS CAPACITOR IS RECOMMENDED.
5. TOLERANCES ARE ± 0.25 [.010] FOR TWO PLACE DECIMALS AND ± 0.5 [.02] FOR ONE PLACE DECIMALS.

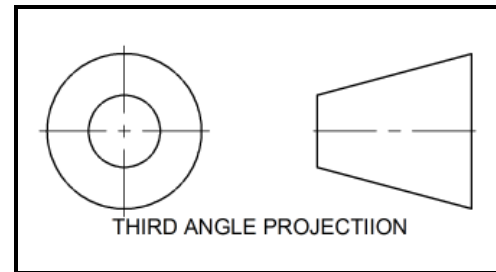

DO NOT SCALE DRAWING

Mechanical Dimensions