

MTWS Series – Femtocell Stratum III TCXO



- Clipped Sinewave Output
- Selected Stratum III Frequencies Available
- Low Phase Noise
- Tape and Reel Available



ELECTRICAL SPECIFICATION:

Frequency Range	See Standard Frequencies Table Other Frequencies Available on Request	
Supply Voltage (Vcc)	+3.3 Vdc	+5.0 Vdc
Current	6.0mA max	
Frequency Stability	Initial Stability at +25°C	±1.50ppm (after reflow)
	Stability vs. Temperature	±0.10ppm (-10°C to +70°C) ±0.28ppm (-40°C to +85°C)
	Stability vs. Supply Voltage	±0.20ppm for 5% change in Supply Voltage
	Stability vs. Load	±0.10ppm for 10% change in Load
Holdover	After 24 hours at +25°C	±40ppb
	After 24 hours from -40°C to +85°C	±370ppb
Long Term Tolerance and Aging	±4.60ppm for all and 20 years aging at +40°C	
Output	Clipped Sinewave	
Amplitude	0.80 Vp-p min	
Load	10K//10pF	
Operating Temperature Range	See Part Number Guide	
Storage Temperature Range	-40°C to +85°C	
Voltage Control Option (Pin 10)	Control Voltage Range	+1.65 VDC ±1.65 VDC
	Frequency Adjustment Range	±5.0 ppm min / ±15.0 ppm
	Slope	Positive
	Input Impedance	100 kΩ
Tri-State Function (Pin 8)	Voh = 70% of Vdd min or No Connection to Enable Output Vol = 30% of Vdd max or grounded to Disable Output (High Impedance)	
Phase Noise (Phase Noise is typical data for 19.200MHZ only, does not guarantee at other frequencies.)	-95dBc/Hz max	10Hz
	-125dBc/Hz max	100Hz
	-130dBc/Hz max	1kHz
	-140dBc/Hz max	10kHz
	-145dBc/Hz max	100kHz

Note: This unit is not hermetically sealed.

PART NUMBER GUIDE:

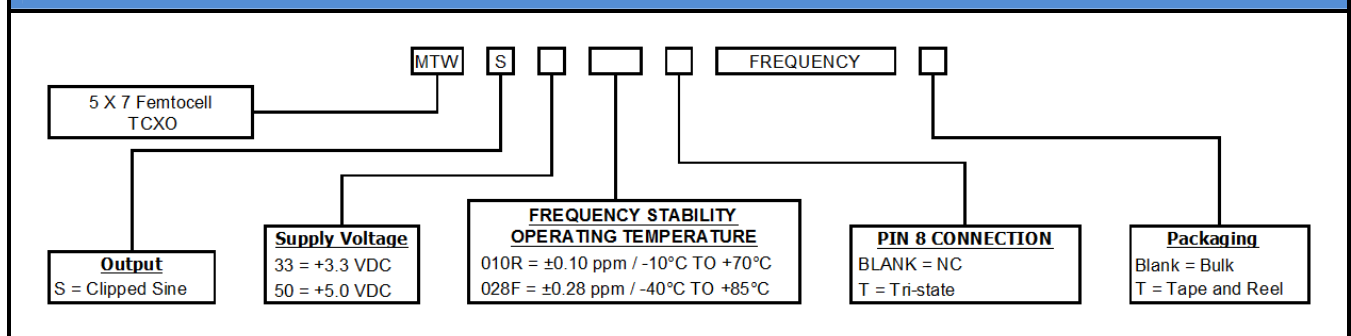

QUALITY MANAGEMENT SYSTEM
CERTIFIED BY DNV
ISO 9001:2008

MMD Components, 30400 Esperanza, Rancho Santa Margarita, CA, 92688
Phone: (949) 709-5075, Fax: (949) 709-3536, www.mmdcomp.com
Sales@mmdcomp.com

Pb | **RoHS**
Free | Compliant

MTWS Series – Femtocell Stratum III TCXO

MECHANICAL & ENVIROMENTAL:

Shock	MIL-STD-883, Method 2002 Cond B
Solderability	MIL-STD-883, Method 2003
Vibration	MIL-STD-883, Method 2007, Cond A
MSL	Level 1 per IPC/JEDEC J-STD 20

MECHANICAL & ENVIROMENTAL:

First Line = MXX.XX (not to exceed 6 characters)
 M = MMD
 XX.XX = Device Frequency
 (5 digits including decimal point)
 Second Line = XXXXXX (Internal Code)
 Third Line = SYWW (not to exceed 6 characters)
 S = Internal Code (can be 1 or 2 characters)
 YWW = Date Code (Year/Week)
 Y = First 2 Digits of Year of Manufacture
 WW = Week of Manufacture

STANDARD FREQUENCIES:

Frequency	Frequency	Frequency
16.384MHZ		
19.200MHZ		
20.000MHZ		
32.768MHZ		
38.400MHZ		
40.000MHZ		

(Other Frequencies Available on Request)

TAPE and REAL DIMENSIONS:

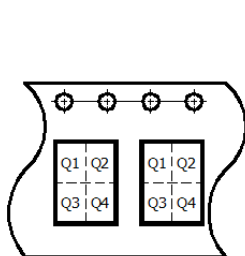
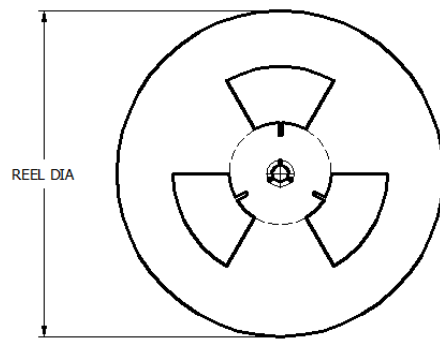
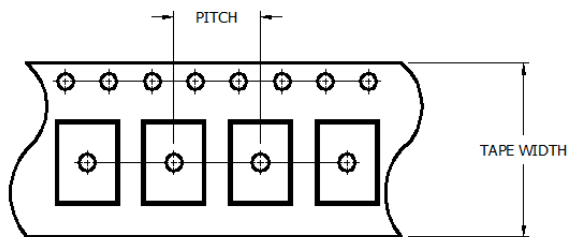

PITCH	8.00 [.315]
TAPE WIDTH	16.00 [.630]
REEL DIA	254 [10 In]
QTY PER REEL	1000
PIN 1 ORIENT.	Q1

NOTES: UNLESS OTHERWISE SPECIFIED

- Applicable Standards / Specifications
 ANSI Y14.5M, Dimensions and Tolerances
 EIA-481-B, 8 mm through 200mm Embossed Carrier Taping and 8 mm and 12 mm Punched Carrier Taping of Surface Mount Components for Automatic Handling.
- Dimensions are in millimeters.
- Tolerances are ± 0.10 [.004] mm unless otherwise specified.
- Do not scale drawing.

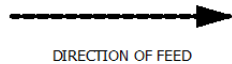

MTWS Series – Femtocell Stratum III TCXO

MECHANICAL DIMENSIONS

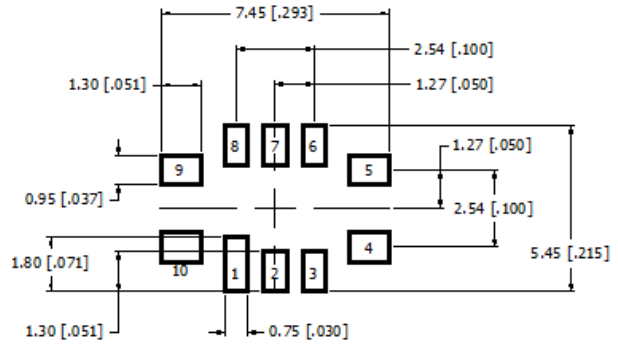
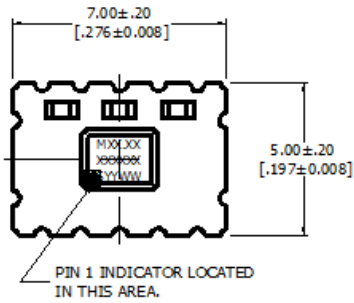

RECOMMENDED LAND PATTERN

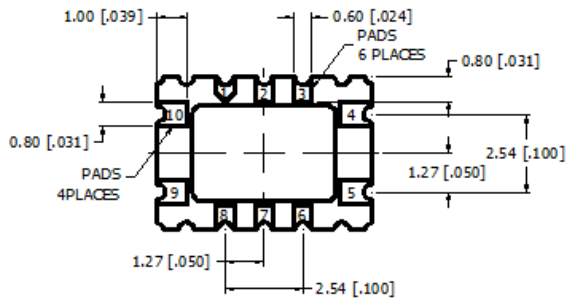

PIN CONNECTIONS	
PIN 1	NC
PIN 2	NC
PIN 3	NC
PIN 4	GND
PIN 5	OUTPUT
PIN 6	NC
PIN 7	NC
PIN 8	NC or TRISTATE
PIN 9	SUPPLY
PIN 10	CONTROL VOLTAGE

NOTES: UNLESS OTHERWISE SPECIFIED

1. APPLICABLE STANDARDS / SPECIFICATIONS: ANSI Y14.5M, DIMENSIONS AND TOLERANCES.
2. DIMENSIONS ARE MILLIMETERS [INCHES]. MILLIMETERS ARE THE CONTROLLING DIMENSIONS, INCHES ARE FOR REFERENCE ONLY.
3. THE PIN NUMBERS ARE FOR REFERENCE ONLY AND ARE NOT TO BE MARKED ON THE UNIT.
4. AN EXTERNAL BYPASS CAPACITOR IS RECOMMENDED.
5. TOLERANCES ARE ± 0.25 [.010] FOR TWO PLACE DECIMALS AND ± 0.5 [.02] FOR ONE PLACE DECIMALS.
6. DO NOT SCALE DRAWING.

